

X 350 mm  
Y 352 mm  
Z 1720 mm

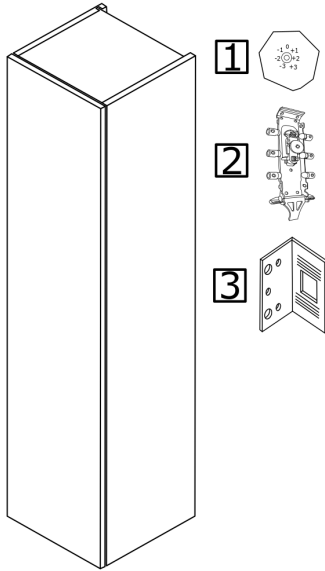

X 350 mm  
Z 1720 mm  
A 60 mm  
B 160 mm  
C mm  
D mm  
E mm  
F mm  
G mm  
H mm  
I mm  
J mm

