

O002

X₁ 500mm

Y₁ 105mm

Z₁ 40mm

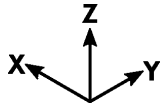

X 700 mm

Y 150 mm

Z 700 mm

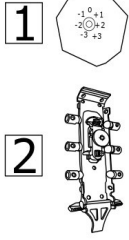
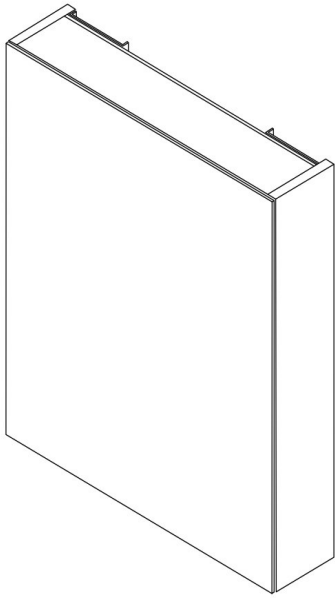

X 700 mm

Z 700 mm

A 80 mm

B 120 mm

C mm

D 1/2 Z

E 1/2 X

F 300 mm

G 300 mm

H mm

I mm

J mm

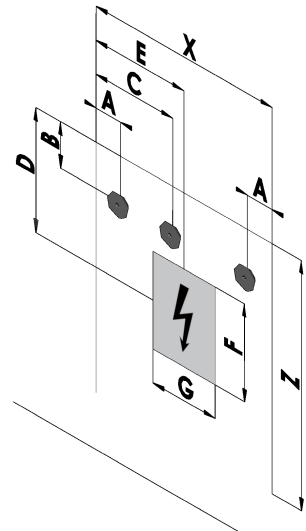

220V-240V~ ; 50Hz-60Hz ; max. 500W ; IP44

