

U023

X: 600mm

Y: 470mm

Z: 130mm

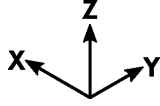

X: 1600 mm

Y: 500 mm

Z: 318 mm

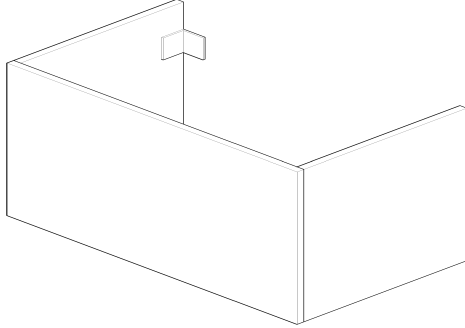
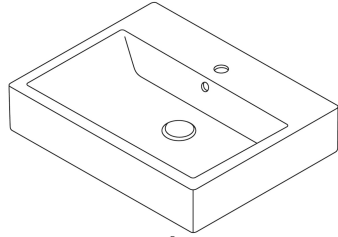

A



A 560 mm

B 600 mm

C 80-120 mm

D 401 mm

E 798 mm

F ... mm

G 656 mm

H 656 mm

I 751/848/1549 mm

J 860 mm

M mm

N mm

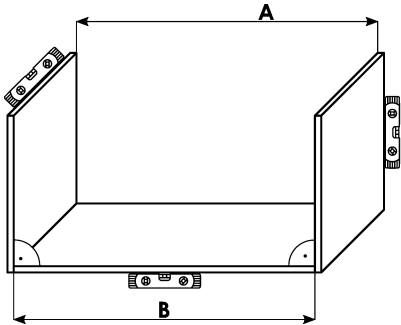
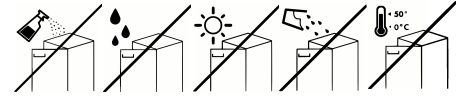
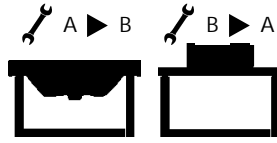
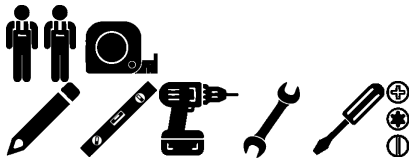
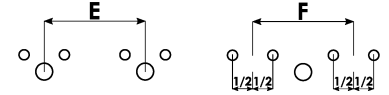
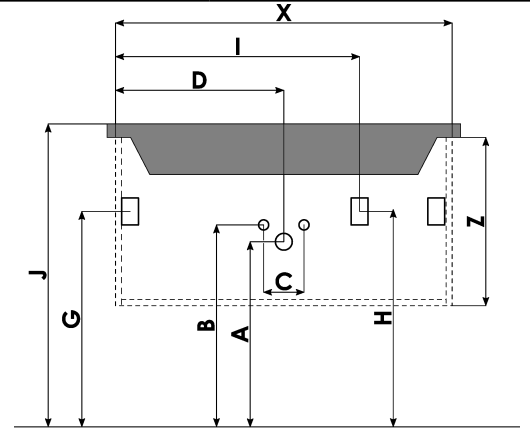

! A=B

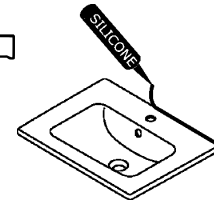
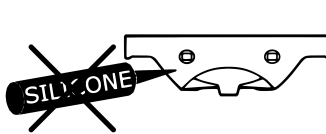
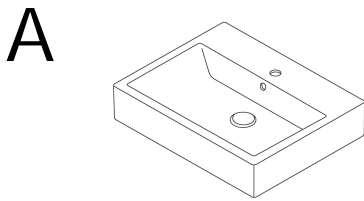
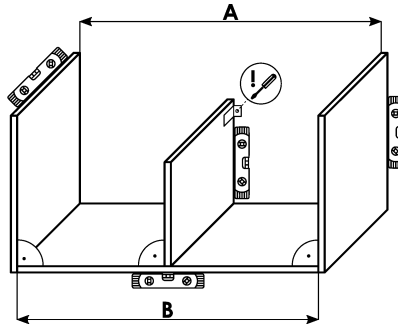

B

