

MODULE SZZ2 120 U023



U023

X: 600mm

Y: 470mm

Z: 130mm



X: 1200 mm

Y: 500 mm

Z: 218 mm

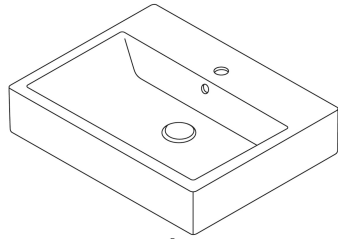

A

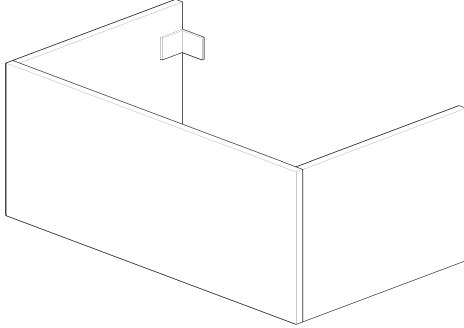

B



- A 480 mm
- B 620 mm
- C 80-120 mm
- D 300 mm
- E ... mm
- F ... mm
- G 656 mm
- H 656 mm
- I 640 mm
- J 860 mm
- M mm
- N mm

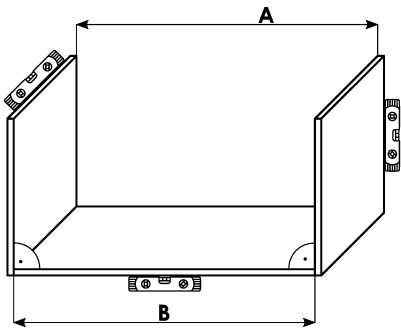
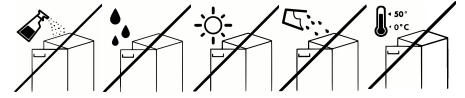
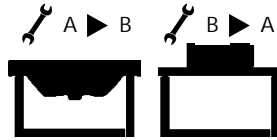
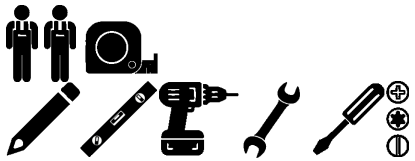
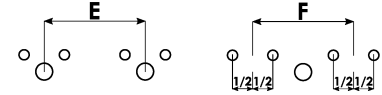
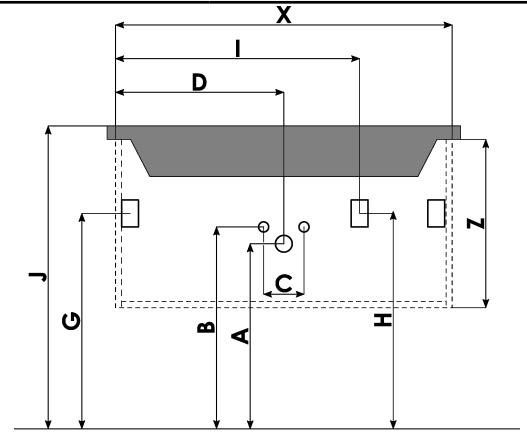

! A=B

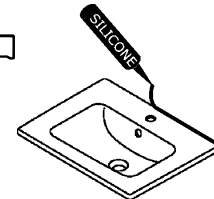
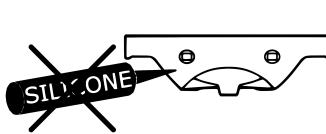
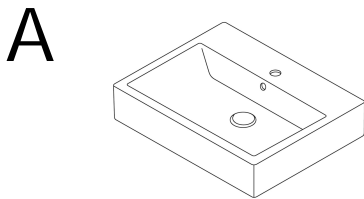
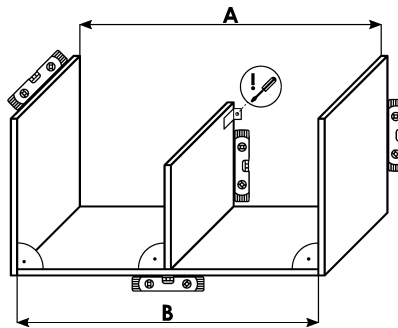

B

