



U118

X₁ 1000mm

Y₁ 455mm

Z₁ 100mm

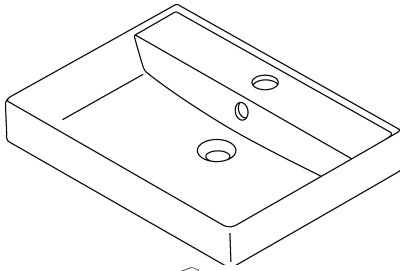

X 1400 mm

Y 500 mm

Z 418 mm



- A 560 mm
- B 600 mm
- C 80-100 mm
- D 700 mm
- E ... mm
- F ... mm
- G 691 mm
- H 658 mm
- I 578/820 mm
- J 860 mm
- M mm
- N mm

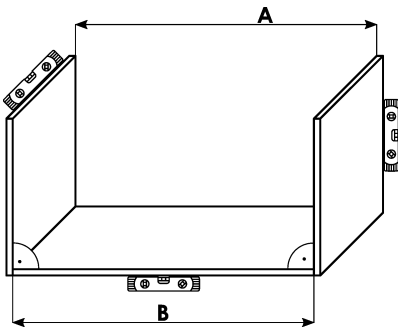
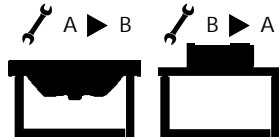
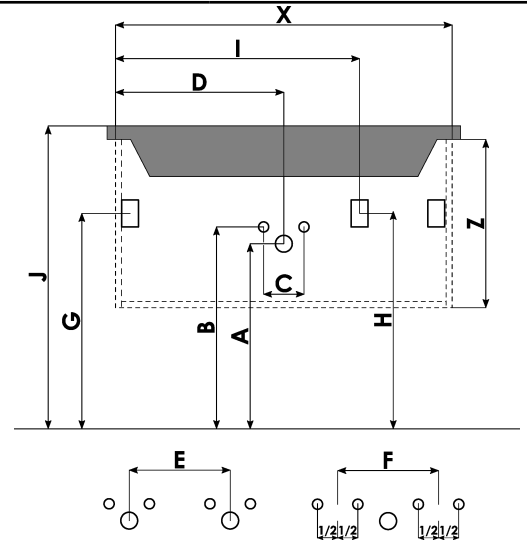

! A=B

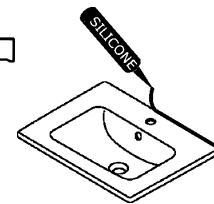
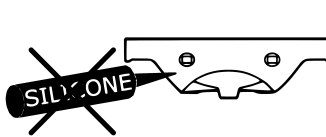
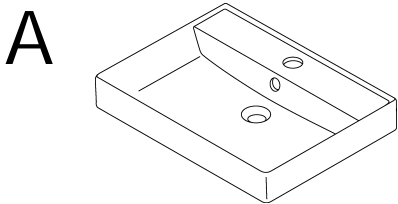
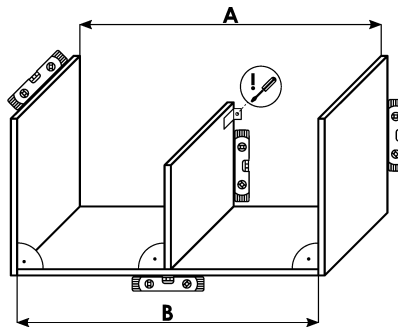

B

