



U023

X: 600mm

Y: 470mm

Z: 130mm



X: 2400 mm

Y: 500 mm

Z: 418 mm

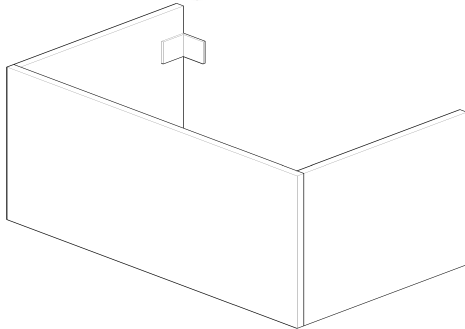
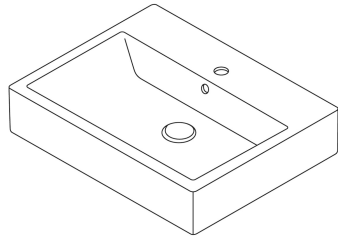

A



- A 560 mm
- B 600 mm
- C 80-100 mm
- D 1200 mm
- E 798 mm
- F ... mm
- G 656 mm
- H 656 mm
- I 752/849/1550/
1647/2348 mm
- J 860 mm
- M mm
- N mm

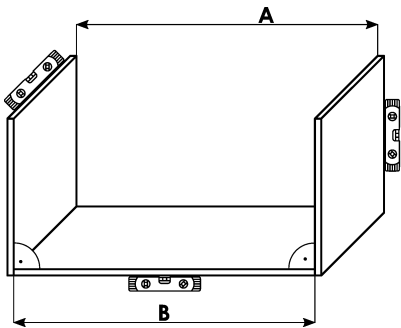
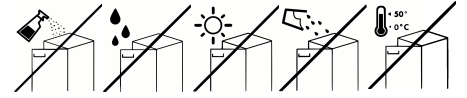
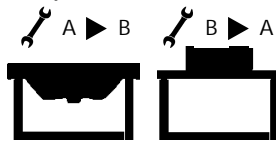
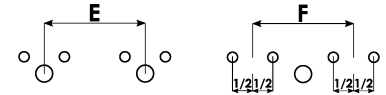
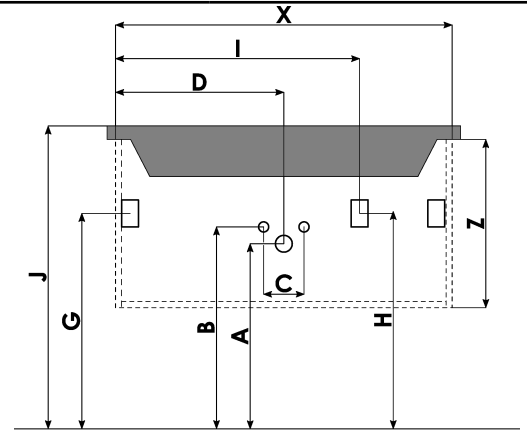

! A=B

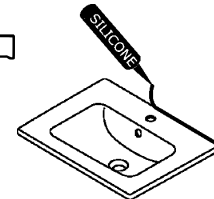
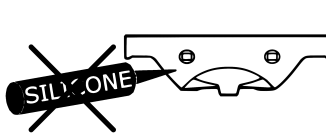
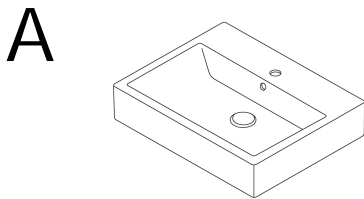
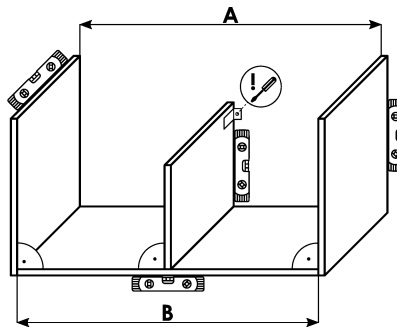

B

