



U113

X<sub>1</sub> 1050mm

Y<sub>1</sub> 460mm

Z<sub>1</sub> 60mm

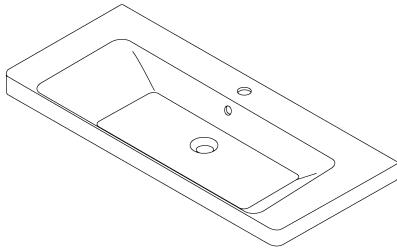

X 1010 mm

Y 438 mm

Z 560 mm

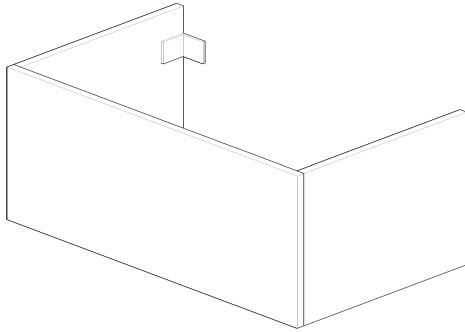

A



- A 550 mm
- B 580 mm
- C 80-120 mm
- D 505 mm
- E --- mm
- F --- mm
- G 662 mm
- H --- mm
- I --- mm
- J 860 mm
- M mm
- N mm

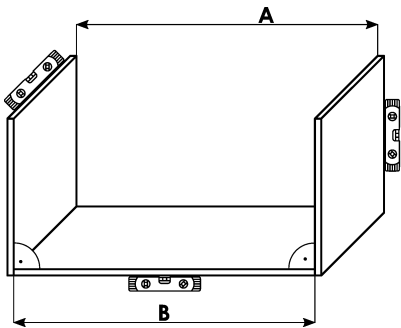
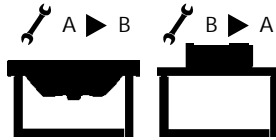
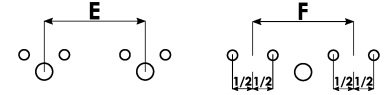
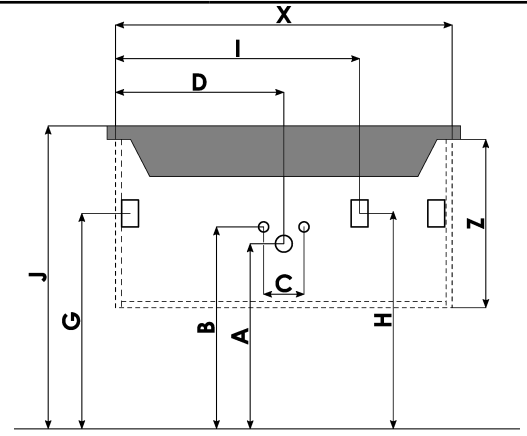

! A=B

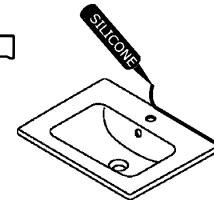
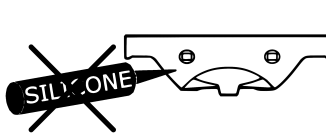
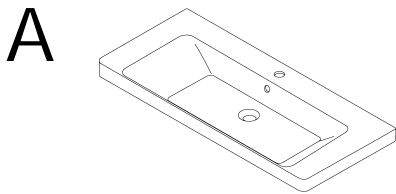
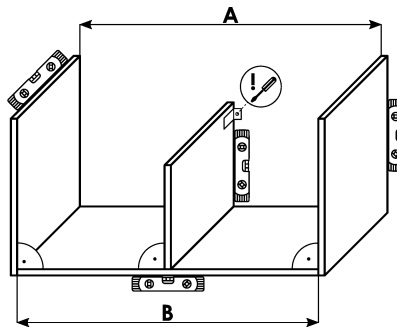

B

