

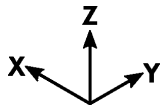

U081

X 1 050 mm
Y 465 mm
Z 95 mm



X 1010 mm
Y 442 mm
Z 520 mm

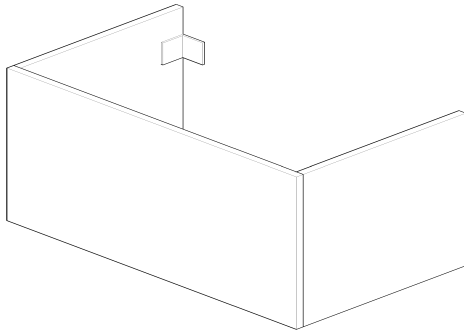
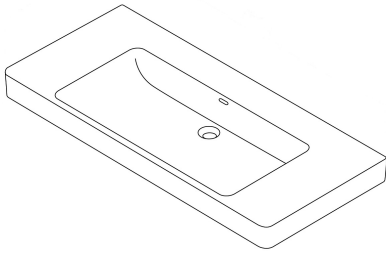

- A X 1010 mm
- Z 520 mm
- A 560 mm
- B 620 mm
- C 80-120 mm
- D 505 mm
- E --- mm
- F --- mm
- G 635 mm
- H --- mm
- I --- mm
- J 860 mm

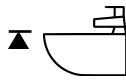
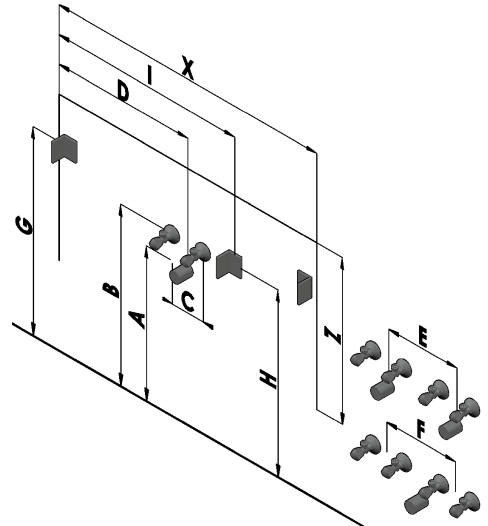

J  Art.No

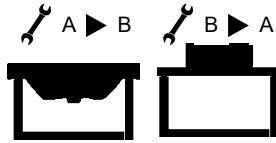
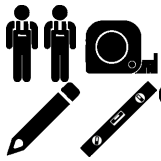

 max. 50 Kg

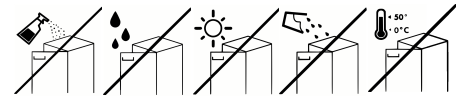

A

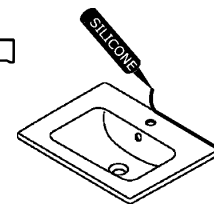
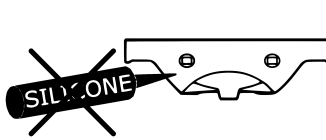
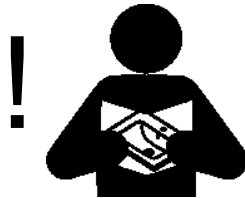
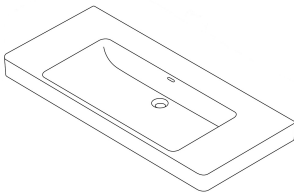

B

